

QUESTIONS OR CONCERNS CONTACT CANARM AT:
1-800-265-1833 (English) • 1-800-567-2513 (French)
Monday through Friday 8:00 AM to 5:00 PM E.S.T.

INSTRUCTIONS PERTAINING TO RISK OF FIRE OR INJURY TO PERSONS
READ ALL INSTRUCTIONS

IMPORTANT SAFETY INSTRUCTIONS

SAVE THESE INSTRUCTIONS

SAFETY PRECAUTIONS:

1. **TURN OFF ELECTRICAL POWER BEFORE STARTING INSTALLATION OF LIGHT FIXTURE.**
 2. **THIS PRODUCT MUST BE INSTALLED IN ACCORDANCE WITH THE APPLICABLE INSTALLATION CODE BY A PERSON FAMILIAR WITH THE CONSTRUCTION AND OPERATION OF THE PRODUCT AND THE HAZARDS INVOLVED.**
- NOTE: Product May Not Look Exactly As Shown In Figures.**

INSTALL EASY CONNECT MOUNTING BRACKET:

STEP 1

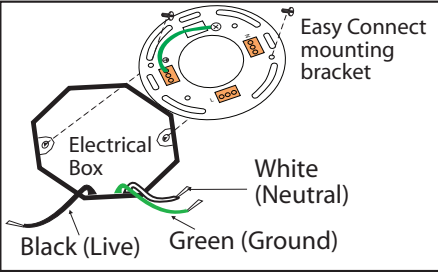

Attach easy connect mounting bracket to electrical box with electrical box screws (not included).

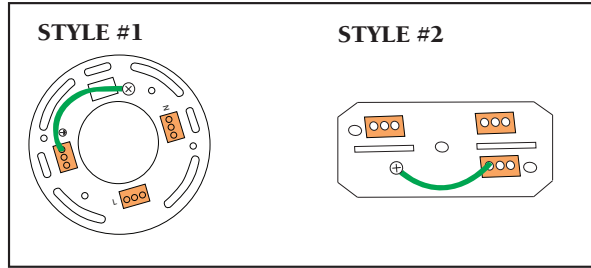

CONNECT HOUSE WIRES

STEP 2 - Option 1

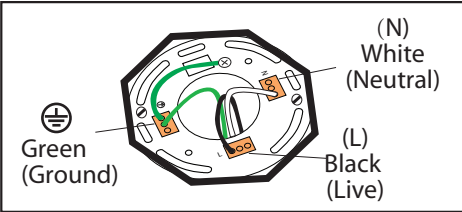

Connect (push) electrical wires from electric box (house wiring) into correct inserts. Black (Live), White (Neutral), Green (Ground)

Option 2 - MULTIPLE ELECTRICAL BOX WIRES

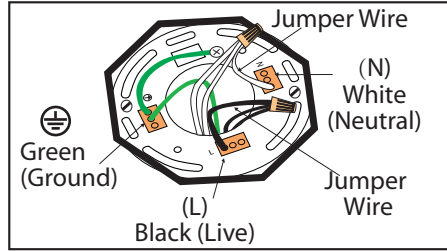

For multiple black (live) & white (neutral) wires joined in the electrical box (house wiring), attach a single "black" and "white" Jumper Wire before connecting. Strip 7mm from a 6" Jumper Wires (AWG 12-24) supplied. Then connect (push) wires into correct inserts.

CONNECT LIGHT FIXTURE

STEP 3

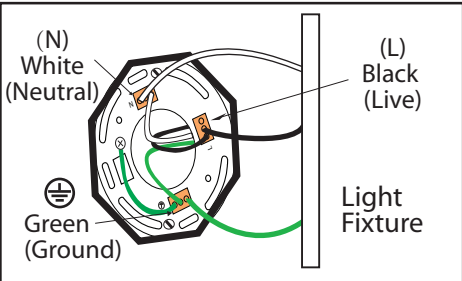

Connect (push) electrical wires from fixture into correct inserts. Black (live), White (neutral), Green (ground)

STEP 4

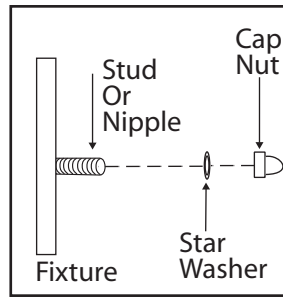

Tuck electrical wires into outlet box and position fixture over studs or nipple on mounting bracket assembly. Secure fixture in place with star washer(s) and cap nut(s).
Note: If required, assemble body and spread the arms of the fixture out evenly.

STEP 5- Optional for some models (Note: Refer to the style of assembly that matches the style of your fixture.)

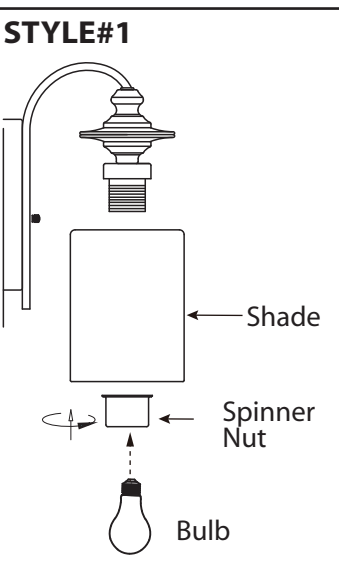

STYLE#1 - Remove spinner nut from socket. Position shade on lamp and secure with spinner nut. Install the specified bulb type and wattage (not included).

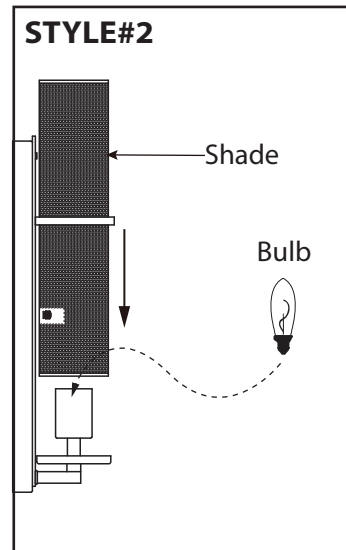

STYLE#2 - Install specified bulb type and wattage (not included). Place shade on socket.